

SPECIFICATION

	HS-7000	HS-7500	HS-5000	HS-5500
SLIT ILLUMINATION	Slit length(mm)	0.3~14		0.3~14
	Slit width(mm)	0~14 continuous		0~14 continuous
	Slit projection	1.167x		1.167x
	Aperture diaphragms	12.5x		
	Filters	Cobalt blue, Red-free, Grey, Heat absorption and Yellow		
	Slit rotation	0°~180° continuous		
PATIENT'S EYE / PRISM	Angle of incidence	0°, 5°, 10°, 15°, 20°	0°~20° continuous	0°, 5°, 10°, 15°, 20°
	Surface working distance	80mm		
MICROSCOPE	Microscope	5x		
	Type	Galilean converging binocular		
	Magnification	5 position rotating drum		
	Eyepieces	12.5x		
	Total magnifications	6x, 10x, 16x, 25x, 40x		
	Real fields of view (mm)	38.5, 22.2, 15.2, 10.5, 6.7		38.5, 22.2, 15.2, 10.5, 6.1
	Interpupillary adjustment	55mm~80mm		
BASE	Vertical movement	28mm		
	Longitudinal movement	78mm		
	Lateral movement	98mm		
	Fine base	10mm		
	Power supply	Free voltage 100-240V AC		
	Voltage frequency	50 / 60Hz		
	Power consumption	70VA		
	Instrument voltage	12V DC		
	Halogen bulb	12V 30W		
	Fixation point bulb	3.4V 20mA		
DIGITAL CAMERA	Image sensor	1/2" interline CCD		
	Image size	up to 1,388 x 1,036 pixels		
	Cell size	4.65μm x 4.65μm		
	Resolution depth	8bit or 12bit Raw RGB, YUV 4:2:2		
	Transmit method	IEEE 1394 (6pin)		
	Transmit speed	400Mbps		
	Frame rate	15fps, 7.5fps, 3.75fps		
	Lens mount	C-Mount		
	Photographing	External trigger or Software trigger		
	Dimension	44mm (W) x 29mm (H) x 63mm (D)		
HIS-5000	Power consumption	3W (12V DC, from IEEE 1394 cable)		
	CPU	Pentium IV, 2GHz		
	Memory	512 MB (over 1GB recommended)		
	Video card	ATI Radeon 9200 (128MB) or similar		
	System	Microsoft Windows NT (with service pack 6), Windows 2000 (with service pack 4)		
	Transmit method	Windows XP, Microsoft Internet Explorer 6 (Explorer 7 recommended) Standard IEEE 1394a Firewire port OHCI 1.1 compatible (with auxiliary 12V power connector if connected to a laptop computer)		
	Monitor	LCD or CRT (minimum resolution 1,280 x 1,024 pixels, over 1,600 x 1,200 pixels recommended)		

OPTION : PC, Table Designs and details can be changed without prior notice for the purposes of improvement.

HUVITZ SLIT LAMP SERIES & IMAGING SYSTEM



Distributed by

TECNOIMAGEN

www.tecnoimagen.com.ar | 0810 333 8273





Advanced optic system, a remarkable difference.

The industry-leading manufacturer, Huvitz, presents a high quality, world-class optic system applied slit lamp series manufactured based on information and experience within the market.

The slit lamp is manufactured beyond the industry standard.



HUVITZ SLIT LAMP HS-7000 / HS-7500

Ultra high end optic system chosen by the most experienced professionals in the industry:
HS-7000 and HS-7500



MICROSCOPE

With the global standard Galilean converging binocular type optic system, the Huvitz high end slit lamp series offers a wider angle, live image and increased accuracy. In conclusion, this slit lamp series offers a better and more successful diagnosis. We invite you to compare our slit lamp series with the competitors analyzing color aberration; view angle and image color clarity.

- 12.5x eye pieces / 6x:38.5mm,10x:22.2mm, 16x:15.2mm, 25x:10.5mm, 40x:6.7mm
- 10x eye pieces(Optional) / 5x:38.5mm, 8x:24mm 12x:15mm, 20x:9mm, 32x:6mm



ILLUMINATION

The 12-volt, 30-watt high luminance halogen lamp provides incredible clarity for both image and video.

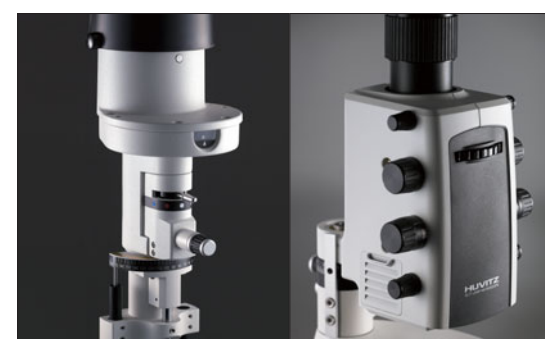

DESIGN

The slit lamps are offered in the Tower Illumination type (HS-7000) and the Integrated Illumination type (HS-7500) slit lamp models. Both types are designed in the industry standard type models used for their proven accuracy and reliability.

MAGNIFICATION CONTROL SYSTEM

The five-position drum-style magnification changer provides a wide range of magnification from 6x to 40x easily accessible by rotating the drum. The design of this system and the uniquely designed Huvitz optic system allows you to offer a more accurate diagnosis and observation to patients without any image distortion in any magnification level.

YELLOW FILTER

A yellow filter is conveniently located near the ocular for effortless insertion of the fluorescein pattern. With a control lever, any filters are easily inserted. (Options include cobalt blue, red free, heat absorption, grey, and yellow.)



INTEGRATED CONTROL

The integrated omni style joystick is simple to control. A trigger button is conveniently mounted on the joystick for easy image and video capture. Images and videos can be stored simultaneously if the slit lamp is connected to image devices.



HUVITZ SLIT LAMP HS-5500 / HS-5000



See the difference by looking through the Huvitz Slit Lamp chosen by opinion leaders in the industry: HS-5000 and HS-5500

ILLUMINATION

The light source is a 12-volt, 30-watt high luminance halogen lamp that provides incredible clarity in both the Tower Illumination and Integrated Illumination type slit lamps.



MICROSCOPE

HS-5000 and HS-5500 deliver crisp images and a wide field of view with the global standard Galilean Converging Binocular optical system.

(6x:38.5mm, 10x:22.2mm, 16x:15.2mm, 25x:10.5mm, 40x:6.7mm)



DESIGN

The slit lamps are offered in the Tower Illumination type (HS-5000) and the Integrated Illumination type (HS-5500) slit lamp models.

Both types are designed in the industry standard type models used for their proven accuracy and reliability.

MAGNIFICATION CONTROL SYSTEM

The five-position drum-style magnification changer provides a wide range of magnification from 6x to 40x easily accessible by rotating the drum.

The design of this system and the uniquely designed Huvitz optic system allows you to offer a more accurate diagnosis and observation to patients without any image distortion in any magnification level.



YELLOW FILTER

A yellow filter is conveniently located near the ocular for effortless insertion of the fluorescein pattern.

With a control lever, any filters are easily inserted. (Options include cobalt blue, red free, heat absorption, grey, and yellow.)

INTEGRATED CONTROL

The integrated omni style joystick is simple to control. A trigger button is conveniently mounted on the joystick for easy image and video capture.

Images and videos can be stored simultaneously if the slit lamp is connected to image devices.



HUVITZ IMAGING SYSTEM HIS-5000

From diagnosis and patient data management to presentation and image processing:
The complete kit of user-friendly image management system



PATIENT INFORMATION MANAGEMENT

MS Access Database system allows you to search symptoms, diagnosed information, and related contents. You can also easily manage data and history of patients.

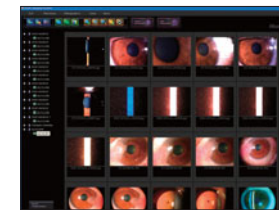

INTUITIVE USER INTERFACE

Intuitive tree-structured user interface allows easy access to and updates of patient information without any complicated clicking.

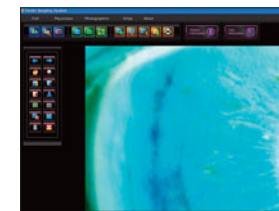

DIGITAL CAMERA

The IEEE 1394 interface in the Huvitz camera system offers you a high mega pixel resolution images with increased speed and a more stable data transmission than a conventional USB port transmission.



QUICK IMAGE & VIDEO SAVING

High performance progressive scan CCD camera provides quick image capture of diagnosed images and videos in real time with a simple click on joystick button.

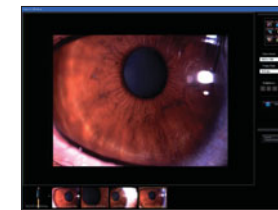

POWERFUL IMAGE PROCESSING

With Live Tool graphic library, all the images such as JPG, TIFF, RAW and many more formats can be adjusted for brightness, contrast, color channel, saturation, inversion, sharpness, red-free, etc.

IMAGE MANIPULATION FOR THE BEST DIAGNOSIS

Compare / The selected images can be magnified, reduced and rotated with various graphic effects for accurate comparison and diagnosis.

Overlay / Correlative animation of images captured in different time frames allows you to identify metastasis of symptoms.

Slide Show / All selected images can be shown in a slide show, which can be used for presentations.

Reference / Images of same symptoms can be registered or searched for further reference.

Report Generation / Automatic patients report export function in MS Word format.

Print / Easy single-click printing of current images.

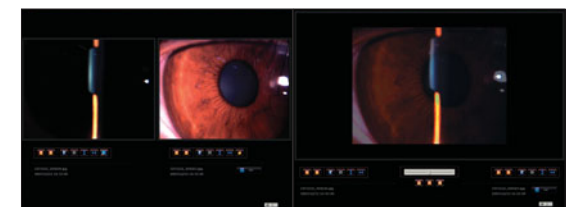

HUVITZ QUALITY, HUVITZ STANDARD



Tens of thousands of repeated electro-mechanical tests and highest international standards ensure Huvitz slit lamps' quality and durability.

HIGH QUALITY STANDARDS

From the design and production process, all Huvitz product goals are made to be durable in extreme conditions.



DURABILITY ACHIEVED AFTER EXTREME TESTS

All the Huvitz slit lamps' modules and joints are designed after tens of thousands of repeated operation tests to ensure long life time usage.

SMOOTH AND EASY PRECISION MOVEMENT

Smooth and precise movements of all operation knobs and joystick factor into making diagnostic procedures even easier.

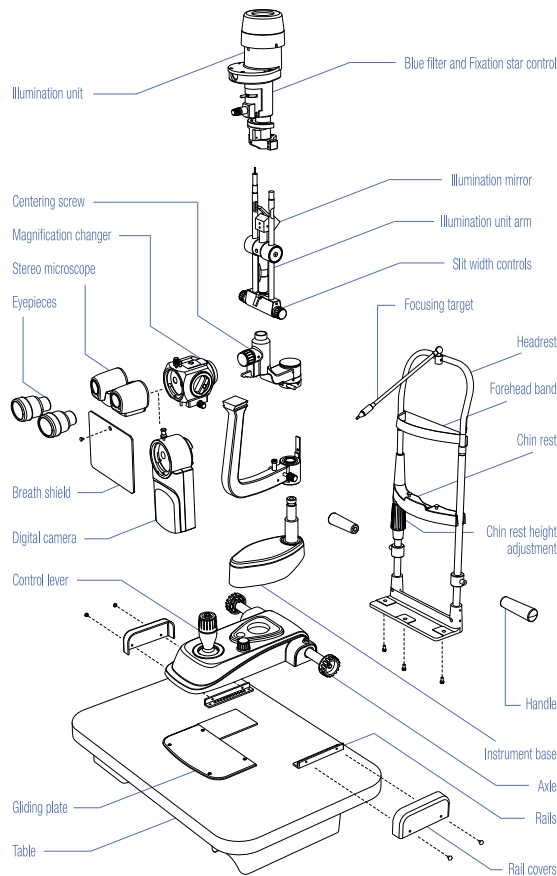
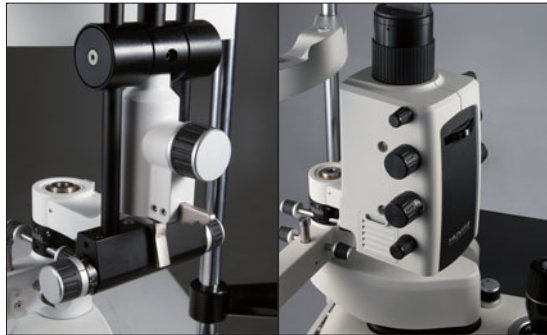

INTERNATIONAL QUALITY ASSURANCE

All Huvitz slit lamps are certified by the international quality assurance system as symbols below indicate.

